

Before you can use the MFC, you must set up the hardware and install the driver. Please read this "Quick Setup Guide" for proper set up and installation instructions.

Step 1



Setting Up the MFC



Step 2



Installing the Driver & Software



Setup is Complete!

For the latest driver and to find the best solution for your problem or question, access the Brother Solutions Center directly from the driver or go to <http://solutions.brother.com>. Keep this "Quick Setup Guide", User's Guide and supplied CD-ROM in a convenient place for quick and easy reference at all times.

Setting Up  
the MFC

Windows®  
USB

Windows®  
Parallel

Windows  
NT® 4.0

Mac® OS  
8.5-9.2

Mac® OS X  
10.1/10.2.1  
or greater

Installing the Driver & Software

# Getting Started

## Carton Components

<p><b>MFC</b></p> <p>1. Control Panel 2. Scanner Cover Release Lever 3. Scanner Cover</p> <p>4. Document Cover 5. Paper Tray 6. Automatic Document Feeder (ADF)</p>		<p><b>Quick Setup Guide</b></p>	
		<p><b>CD-ROM</b></p>	
		<p><b>User's Guide</b></p>	
<p><b>Output Paper Support</b></p>	<p><b>Paper Support</b></p>	<p><b>Ink Cartridges (Black, Cyan, Yellow, Magenta)</b></p>	
<p><b>Cable Tie and Filter Core for Parallel Interface Cable</b></p>	<p><b>Telephone Line Cord</b></p>	<p><b>Test Sheet (USA only)</b></p>	<p><b>Accessory Order Form</b></p>

Carton components may differ from one country to another.  
Save all packing materials and the carton.



- The interface cable is not a standard accessory. Please purchase the appropriate interface cable for the interface you intend to use (Parallel or USB).
- For Parallel use a shield interface cable that is IEEE 1284-compliant.
- Use only a parallel interface cable or USB interface cable that is not longer than 6 feet long (1.8 meters).

## Control Panel

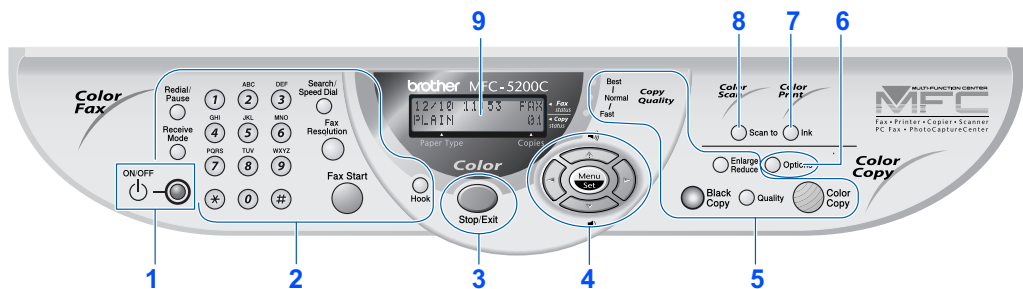

1. ON/OFF key	4. Navigation keys	7. Ink key
2. Fax and Telephone keys	5. Copy keys and indicators	8. Scan to key
3. Stop/Exit key	6. Options key	9. Liquid Crystal Display (LCD)



For the details of the control panel, see "MFC-5200C Control Panel Overview" in Chapter 1 of the User's Guide.

# Table of Contents

## Step 1 Setting Up the MFC

1. Removing the Protective Parts .....	2
2. Attaching the Paper Supports .....	2
3. Load Paper .....	3
4. Install Phone Line and Power Cord .....	3
5. Installing the Ink Cartridges .....	4
6. Color Block Quality and Alignment Check .....	6
7. Selecting a Receive Mode .....	8
8. Setting a Date and Time .....	8
9. Setting Your Station ID .....	9
10. Selecting Your Language (Canada Only) .....	9
11. Sending in the Warranty Registration and Test Sheet (USA Only) .....	9

## Step 2 Installing the Driver & Software

Windows®	Supplied CD-ROM (MFC Software Suite) .....	10
	For USB Interface Cable Users	
	(For Windows® 98/98SE/Me/2000 Professional/XP) .....	12
	■ For Windows® 98/98SE/Me Users Only .....	15
	■ For Windows® 2000 Professional Users Only .....	17
	■ For Windows® XP Users Only .....	18
	For Parallel Interface Cable Users	
	(For Windows® 95/98/98SE/Me/2000 Professional/XP) .....	19
	■ For Windows® 95/98/98SE/Me Users Only .....	22
	■ For Windows® 2000 Professional Users Only .....	23
■ For Windows® XP Users Only .....	24	
For Windows NT® Workstation Version 4.0 Users .....	25	
Macintosh®	For Mac® OS 8.5 - 9.2 Users .....	28
	For Mac® OS X 10.1, 10.2.1 or greater Users .....	30

 <p><b>Warning</b></p>
Indicates warnings that must be observed to prevent possible personal injury.

Indicates cautions that must be observed to use the MFC properly or prevent damage to the MFC.

 <p><b>Hint</b></p>
Indicates notes and useful tips to remember when using the MFC.

 <p><b>User's Guide</b></p>
Indicates reference to the User's Guide.

# Step 1

# Setting Up the MFC

## 1 Removing the Protective Parts



**Do NOT connect the interface cable. Connecting the interface cable is done when installing the driver.**

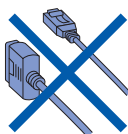

- 1 Remove the protective seals.
- 2 Open the scanner cover by pulling the release lever towards you.

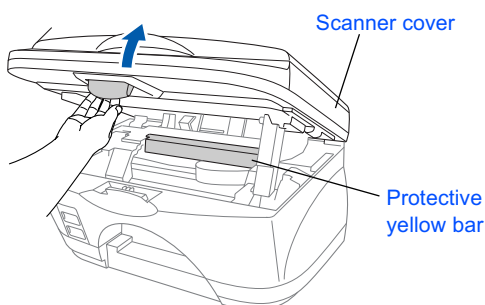

- 3 Remove the protective yellow bar and the wiper stopper.

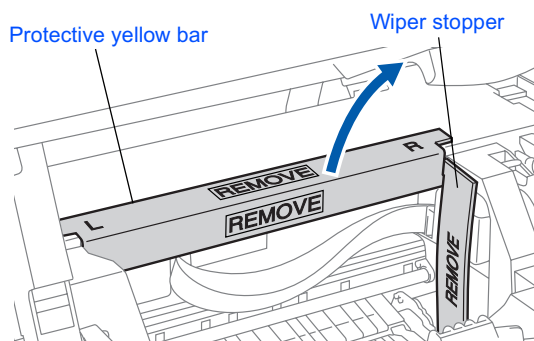

*Do not throw away the protective yellow bar and the wiper stopper. You will need it in the future to transport the machine.*

- 4 Close the scanner cover.

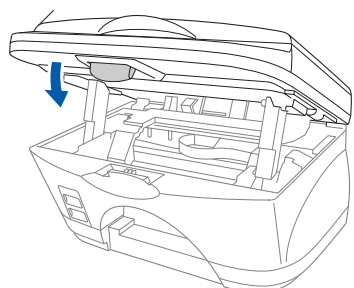

## 2 Attaching the Paper Supports

- 1 Attach the paper support to the paper tray.

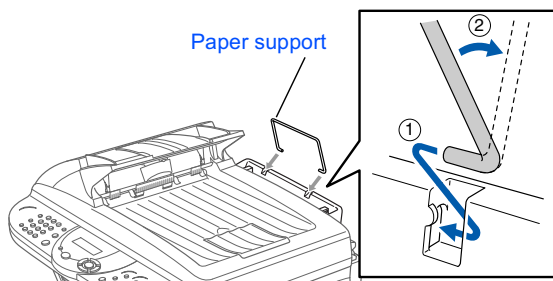

- 2 Attach the output paper support to the paper output slot, and then pull out the extension.

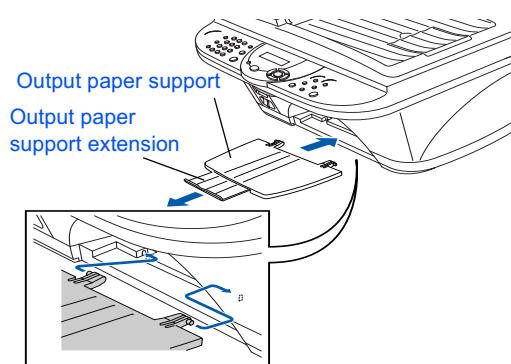

### 3 Load Paper

- 1 Fan the stack of paper well to avoid paper jams and misfeeds.

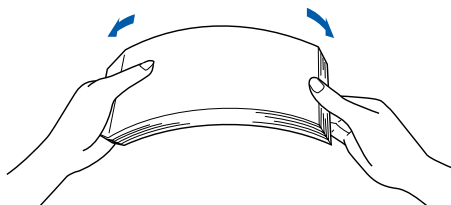

- 2 Gently insert the paper. Make sure the print side is towards you and the paper is below the maximum paper mark.

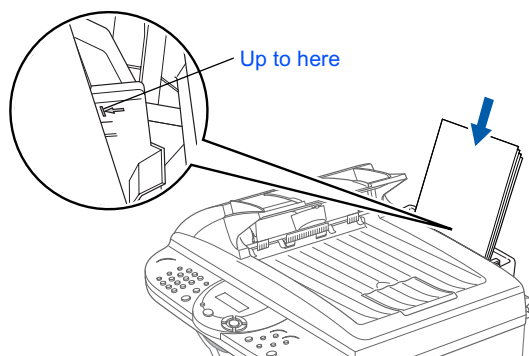

You can load up to 100 sheets of 20 lb (80 g/m<sup>2</sup>) letter size paper. For more details, see "Paper capacity of the Paper Tray" in Chapter 2 in User's Guide.

- 3 Press and slide the paper guide to fit the paper width.

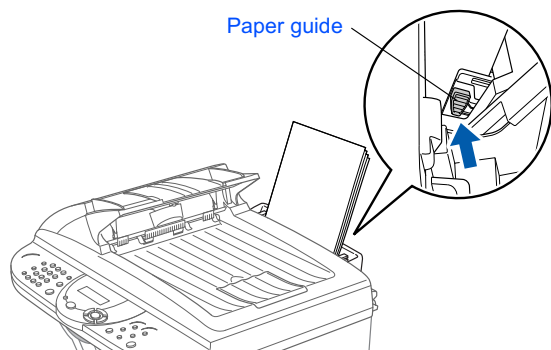

### 4 Install Phone Line and Power Cord

- 1 Connect the power cord.

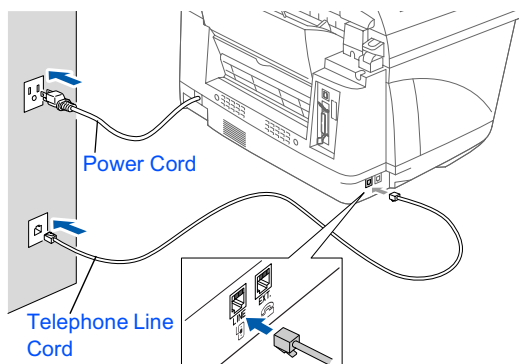

- 2 Connect one end of the telephone line cord to the jack on the MFC marked **LINE** and the other end to a modular wall jack.



**Do not connect the Parallel or USB cable yet.**

#### **Warning**

- The MFC must be grounded using a 3-prong plug.
- Since the MFC is grounded through the power outlet, you can protect yourself from potentially hazardous electrical conditions on the telephone network by keeping the power to your MFC on when you connect it to a telephone line. Similarly, you can protect yourself when you want to move your MFC by disconnecting the telephone line first and then the power cord.

To be continued

Windows®  
USBWindows®  
ParallelWindows  
NT® 4.0Mac® OS  
8.5-9.2Mac® OS X  
10.1/10.2.1  
or greater

# Step 1

# Setting Up the MFC



If you are sharing one phone line with an external telephone, connect it as shown below.

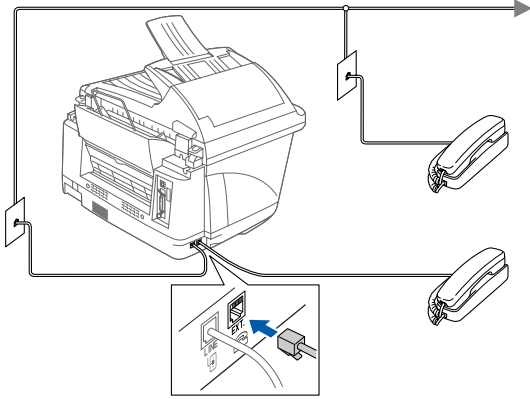

If you are sharing one phone line with an external telephone answering machine, connect it as shown below.



Please set the receive mode to **EXTERNAL TAD**.  
For more details, see "Connecting the MFC" in Chapter 1 of the User's Guide.

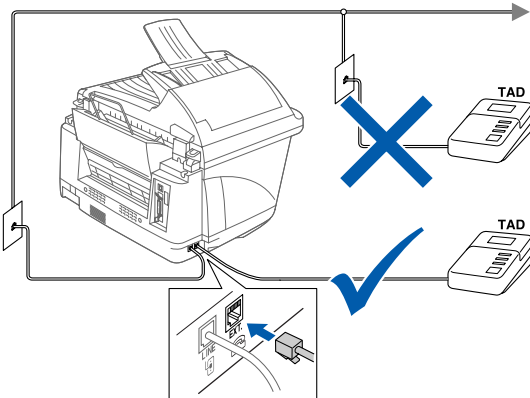

## 5

## Installing the Ink Cartridges



### Warning

If ink gets in your eyes irrigate them with water immediately, and if irritation occurs consult a doctor.

- 1 Make sure that the power is turned on. The LCD shows;

CHECK CARTRIDGE  
Open cover, then...

- 2 Open the scanner cover by pulling the release lever towards you. The print heads will move to the ink replacement position.

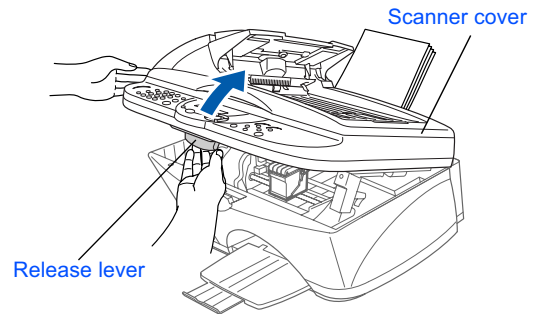

- 3 Push the four colored ink cartridge covers one at a time so they pop up.

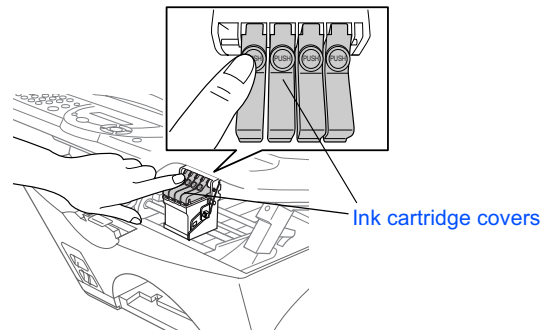

- 4 Remove the white shipping cover by pulling it towards you.

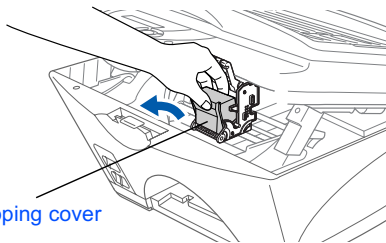

- The bottom of the white shipping cover is wet with ink that will cause stains, so wipe it clean before you place it down.
- Do not throw away the white shipping cover. You will need it when you transport the machine.

- 5 Take out black ink cartridge.

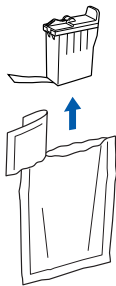

- 6 Carefully remove the sealing tape from the bottom of the ink cartridge.

**To prevent spilling ink and staining your hands and clothing, peel the sealing tape gently and slowly.**

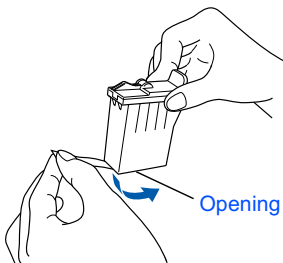

**Do not touch the ink opening on the cartridge or removed tape.**

- 7 Gently insert the black ink cartridge in the black ink position.

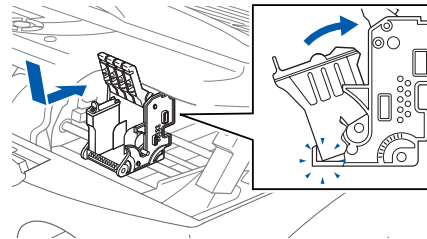

- 8 Press the cover down until it clicks.

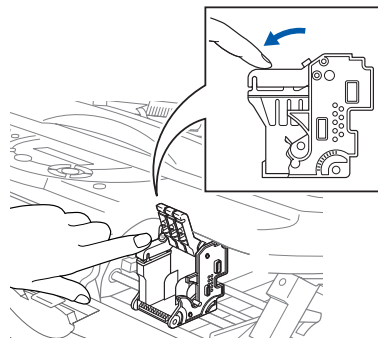

- 9 Repeat Steps 5 to 8 to install each color ink cartridge. Match the colors of the ink cartridge covers.

- 10 Close the scanner cover. The MFC will enter a head cleaning cycle for approximately **six minutes**.

CLEANING  
PLEASE WAIT



- **DO NOT** remove ink cartridges if you do not need to replace them. If you do so, it may reduce the ink quantity and the MFC will not know the quantity of ink left in the cartridge.
- **DO NOT** shake the ink cartridges. If you do so, the ink may spill when you take off the sealing tape. If ink stains your body or clothing, wash with soap or detergent immediately.
- **DO NOT** refill the ink cartridges. Attempting to use refilled cartridges and using incompatible inks may cause damage to the print head in this machine and such damage will not be covered by warranty. **Warranty coverage does not apply to problems caused by the use of 3rd party ink or 3rd party ink cartridges. Use only genuine Brother ink cartridges.**



- *If you mix the colors by installing an ink cartridge in the wrong color position, you must clean the print head several times after correcting the cartridge installation and before you start printing.*
- *Once you open an ink cartridge, install it in the MFC and use it up within six months of installation. Use unopened ink cartridges by the expiration date written on the cartridge package.*
- *If INK EMPTY shows on the LCD after you install the ink cartridges, check to make sure the ink cartridges are installed correctly.*

## 6

## Color Block Quality and Alignment Check

- 1 After the cleaning cycle is finished, the LCD shows;

SET PAPER AND  
PRESS FAX START

- 2 Make sure the paper is loaded in the paper tray.  
Press the **Fax Start** key.
- 3 The MFC starts printing the PRINT QUALITY CHECK SHEET (only during initial ink cartridge installation).

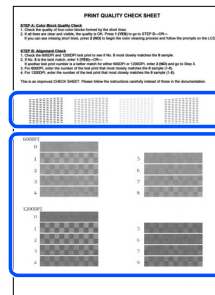

Check in **Step A**

Check in **Step B**



## Step A: Color Block Quality Check

- 1 The LCD shows:

```
IS STEP "A" OK?
1.YES 2.NO
```

Check the quality of the four color blocks formed by the short lines printed on the sheet.

(BLACK/CYAN/YELLOW/MAGENTA)

- 2 If all lines are clear and visible, press the 1 key on the dial pad to go to **STEP B: Alignment Check**.

---OR---

If you can see missing short lines, press the 2 key on the dial pad and go to 3.

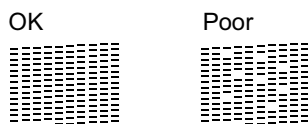

- 3 The LCD asks you if the print quality is OK for each color. Press the 1 key or 2 key on the dial pad.

```
BLACK OK?
1.YES 2.NO
```

When you have finished selecting the 1 key (YES) or the 2 key (NO) for magenta, the LCD shows:

```
START CLEANING?
1.YES 2.NO
```

Press the 1 key (YES), and then MFC starts cleaning the colors.

After cleaning is finished, press the **Fax Start** key. The MFC starts printing PRINT QUALITY CHECK SHEET again and goes back to the first step of STEP A.

## Step B: Alignment Check

- 1 The LCD shows:

```
IS STEP "B" OK?
1.YES 2.NO
```

Check the 600 DPI and 1200 DPI test print to see if **No.5** most closely matches the OK sample (**No.0**). Press the 1 key if **No.5** matches it.

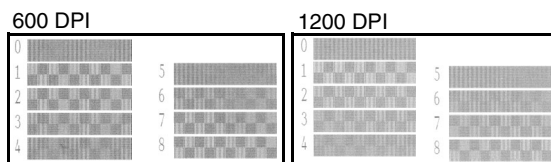
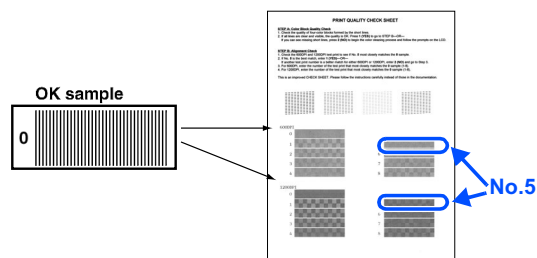

If another test print number is a better match for either 600 DPI or 1200 DPI, press the 2 key to select NO and go to 2.

- 2 For 600 DPI, select the number from 1 to 8 that most closely matches the **No.0** sample and enter it using the dial pad.

```
600DPI ADJUST
SELECT BEST #
```

- 3 For 1200 DPI, enter the number from 1 to 8 that most closely matches the **No.0** sample.

```
1200DPI ADJUST
SELECT BEST #
```

The Quality check is now complete.

# Step 1

# Setting Up the MFC

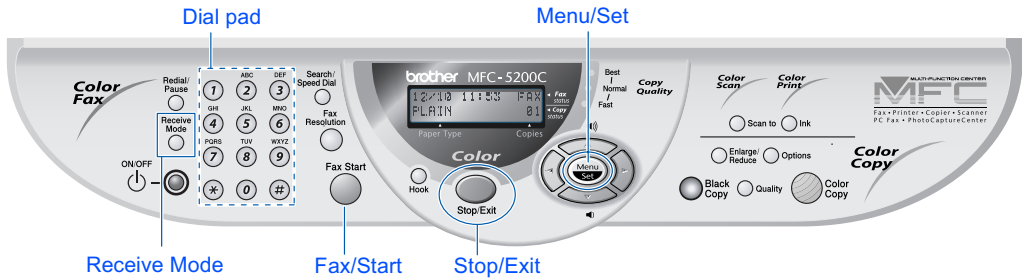

## 7 Selecting a Receive Mode



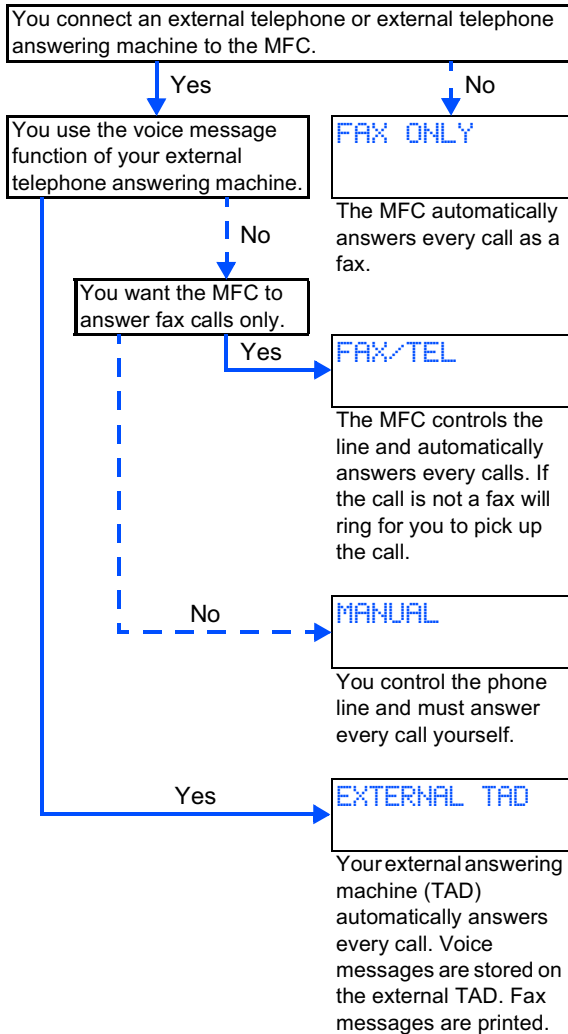

Choose the mode which best suits your needs by pressing the **Receive Mode** key repeatedly.



For more details, see "Setup Receive" in Chapter 5 of the User's Guide.

## 8 Setting a Date and Time

The MFC displays the date and time, and prints it on every fax you send.

- 1 Press the **Menu/Set** key.
- 2 Press the **1** key.
- 3 Press the **3** key.
- 4 Enter the last two digits of the year on the dial pad, and then press the **Menu/Set** key.  
  
(e.g. Enter **0, 3** for 2003.)
- 5 Enter the two digits for the month on the dial pad, and then press the **Menu/Set** key.  
  
(e.g. Enter **0, 9** for September.)
- 6 Enter the two digits for the day on the dial pad, and then press the **Menu/Set** key.  
  
(e.g. Enter **0, 6**.)
- 7 Enter the time in 24-hour format on the dial pad, and then press the **Menu/Set** key.  
  
(e.g. Enter **1, 5, 2, 5** for 3:25 P.M.)
- 8 Press the **Stop/Exit** key.



If you want to repeat from step 1, press the **Stop/Exit** key.

## 9 Setting Your Station ID

You should store your name and fax number to be printed on all fax pages that you send.

- 1 Press the **Menu/Set** key.
- 2 Press the **1** key.
- 3 Press the **4** key.
- 4 Enter your fax number (up to 20 digits) on the dial pad, and then press the **Menu/Set** key.

```
STATION ID
FAX: 908XXXXXXXX
```

- 5 Enter your telephone number (up to 20 digits) on the dial pad, and then press the **Menu/Set** key. (If your telephone number and fax number are the same, enter the same number again.)

```
STATION ID
TEL: 908XXXXXXXX
```

- 6 Use the dial pad to enter your name (up to 20 characters), and then press the **Menu/Set** key.

```
STATION ID
NAME: ANDY
```

 Refer to the following chart for entering your name.



Press key	One time	Two times	Three times	Four times
2	A	B	C	2
3	D	E	F	3
4	G	H	I	4
5	J	K	L	5
6	M	N	O	6
7	P	Q	R	S
8	T	U	V	8
9	W	X	Y	Z

 For more details, see "Setting the Station ID" in Chapter 4 of the User's Guide.

- 7 Press the **Stop/Exit** key.

 If you want to repeat from step 1, press the **Stop/Exit** key.

## 10 Selecting Your Language (Canada Only)

- 1 Press the **Menu/Set** key.
- 2 Press the **1** key.
- 3 Press the **8** key.
- 4 Select your language (ENGLISH or FRENCH) by using  or , and then press the **Menu/Set** key.

```
LOCAL LANGUAGE
ENGLISH
```

- 5 Press the **Stop/Exit** key.

## 11 Sending in the Warranty Registration and Test Sheet (USA Only)

- 1 Fill out the Warranty Registration and Test Sheet.



- 2 Place the sheet face up in the Automatic Document Feeder.

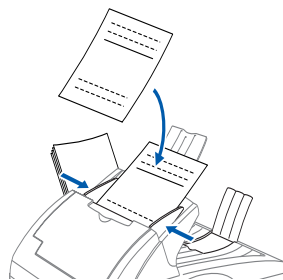

- 3 Enter the fax number: 1-877-268-9575.
- 4 Press the **Fax Start** key.

Go to Next page to  
install the driver

## Supplied CD-ROM (MFC Software Suite)

You can find a variety of information on the CD-ROM.

### Windows®



#### **Install Software**

You can install printer, PC FAX Send/Receive, scanner drivers and the various utility items, including Paper Port and TextBridge OCR.



#### **On-Line Registration**

You will be pointed to a directory on the Brother Product Registration Web Page.



#### **On-Line Documentation**

View the User's Guide and other documentation in PDF format. (Viewer included)



#### **Brother Support**

View contact information for Brother Customer Service and how to locate a Brother Authorized Service Center.



#### **Help**

Helpful hits.

### Macintosh®

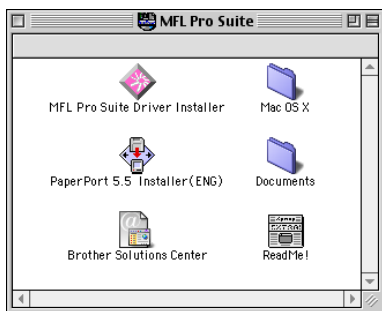

#### **MFL Pro Suite Driver Installer**

You can install printer, PC FAX Send, and scanner drivers for OS 8.5 - 9.2 (scanner driver only available for OS 8.6 - 9.2)



#### **Documents**

View the User's Guide and other documentations in PDF format.



#### **PaperPort 5.5 Installer (ENG)**

You can install a document management application used to view scanned documents (Mac OS X not supported).



#### **Mac OS X**

**(For Native Mac OS X 10.1, 10.2.1 or greater)**

You can install the printer, scanner drivers and remote setup program for Mac OS X (scanner driver only available for OS X 10.2.1 or greater).



#### **Brother Solutions Center**

You can access the Brother Solutions Center which is a Web site offering information about your Brother product including FAQs, User Guides, Driver updates and Tips for using your machine.



#### **ReadMe!**

You can get important information and troubleshooting tips.



Follow the instructions on this page for your operating system and interface cable.

Setting Up  
the MFC

Windows®



**USB Interface Cable Users** ..... Go to page 12  
(For Windows® 98/98SE/Me/2000 Professional/XP)

Windows®  
USB



**Parallel Interface Cable Users** ..... Go to page 19  
(For Windows® 95/98/98SE/Me/2000 Professional/XP)

Windows®  
Parallel



**Windows NT® Workstation Version 4.0 Users...** Go to page 25  
(For Parallel Interface Cable Users)

Windows  
NT® 4.0

Macintosh®



**For Mac® OS 8.5 to 9.2 Users** ..... Go to page 28

Mac® OS  
8.5-9.2



**For Mac® OS X 10.1, 10.2.1 or greater Users** ..... Go to page 30

Mac® OS X  
10.1/10.2.1  
or greater

# Step 2

# Installing the Driver & Software



## For USB Interface Cable Users

(For Windows® 98/98SE/Me/2000 Professional/XP)

Make sure that you have completed the instructions from Step 1 “Setting Up the MFC” on pages 2 to 9.

If you are using Windows® 2000 Professional:

To access the PhotoCapture Center™ features from your PC you must be connected using USB and you may have to install a Windows® 2000 update first.

There are two ways to install the Windows® 2000 update:

- A) Download Service Pack 3 from the Microsoft® Web page and install it. We recommend this method because it includes other bug fixes for Windows® 2000.
- B) Install the Windows® 2000 update from the MFC Software Suite installer. You can install it by following the steps below:
  - 1. Follow the installation steps from ① to ⑥.
  - 2. Click **OK** to start installation of the update.
  - 3. Click **OK** to restart your PC.
  - 4. After the PC restarts, the installation will automatically continue.



*If the installation does not continue automatically, please open the MFC Software Suite installer menu again by double-clicking the **setup.exe** program on the Brother CD-ROM, and continue from Step ④ to install the Multi-Function Link® Pro Suite.*

- ① Unplug the MFC from the AC outlet and disconnect it from your computer, if you already connected an interface cable.

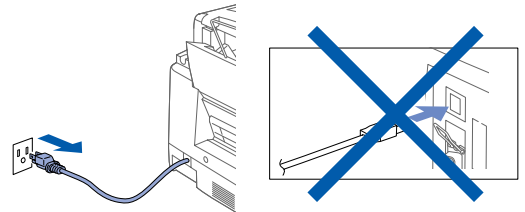

- ② Turn on your computer. (For Windows® 2000 Professional/XP, you must be logged on as the administrator.)
- ③ Insert the supplied CD-ROM into your CD-ROM drive.



- ④ The CD-ROM main menu will appear. Click **Install Software**.



*If this window does not appear, use Windows® Explorer to run the **setup.exe** program from the root directory of the Brother CD-ROM.*

- 5 Click **Multi-Function Link® Pro Suite** in Main Application. \*1

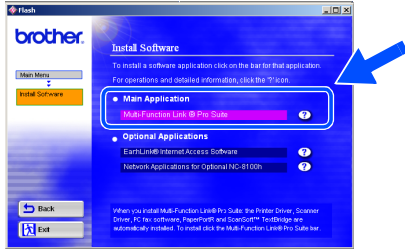

\*1 *Multi-Function Link® Pro Suite includes Printer Driver, Scanner Driver, ScanSoft™ PaperPort®, ScanSoft™ Text Bridge®, PC-FAX software, Remote Setup and True Type fonts. PaperPort® is a document management application for viewing scanned documents. ScanSoft™ TextBridge®, which is integrated into PaperPort®, is an OCR application that converts an image into text and inserts it into your default word processor.*

- 6 Click **Install**.

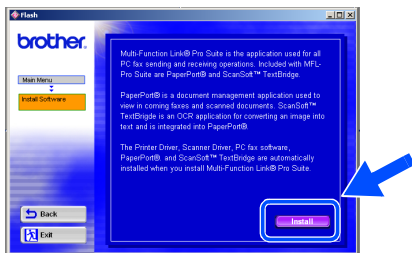

 If you see the following screen, click **OK** to install the Windows® updates. After the updates are installed your PC will restart and automatically continue the installation.

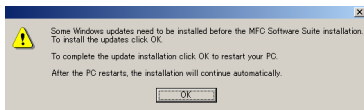

If the installation does not continue automatically, please open the installer menu again by double-clicking the **setup.exe** program on the Brother CD-ROM, and continue from Step 4.

- 7 When the PaperPort® 8.0 SE Setup window is displayed, click **Next**.

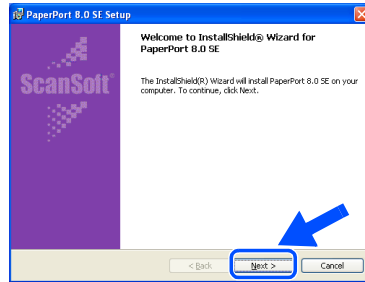

- 8 After reading and accepting the License Agreement, enter your user information and click **Next**.

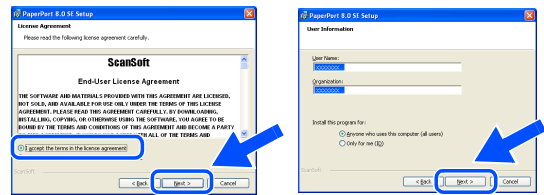

- 9 Select **Typical** and click **Next**.

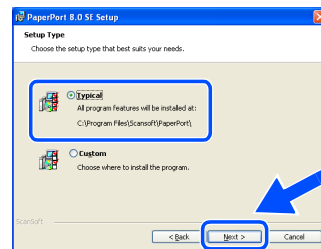

- 10 Click **Install** and PaperPort® will start installing on your computer.

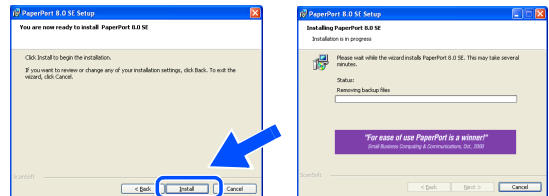

**To be continued** 

# Step 2

# Installing the Driver & Software



For USB Interface Cable Users

(For Windows® 98/98SE/Me/2000 Professional/XP)

- 11 When the Registration screen is displayed, make your selection and follow the on screen instructions.

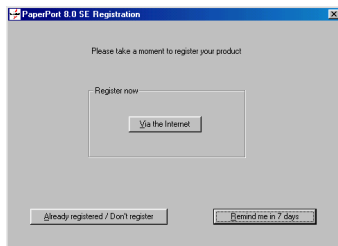

- 12 Click **Finish** to complete installation.

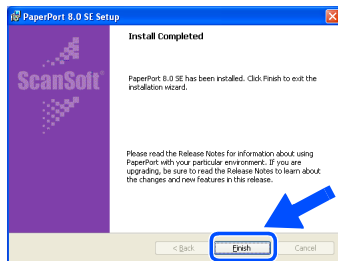

- 13 When the Brother MFL Pro Suite Installation window appears, click **Next**. \*2

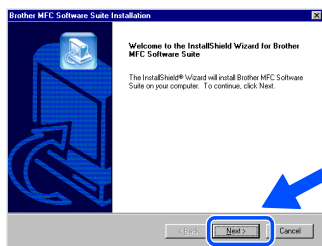

\*2 If an error message appears during the installation process, or if you have previously installed the MFL Pro Suite, you will first have to uninstall it. From the **Start** menu, select **Programs, Brother, Brother MFL Pro Suite, Uninstall**, and then follow the instructions on the screen.

- 14 When Software License Agreement window appears, click **Yes**.

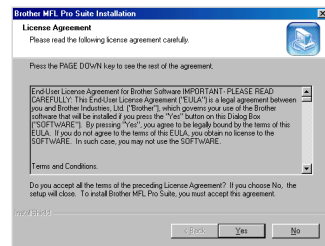

- 15 Select **Standard**, and then click **Next**. The application files will be copied to your computer.

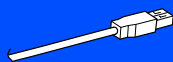
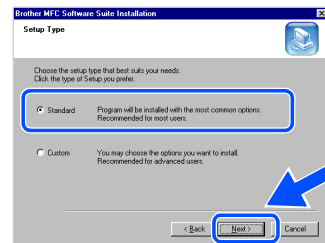

Windows® 98/98SE/Me Users  
→ Go to page 15  
Windows® 2000 Professional Users  
→ Go to page 17  
Windows® XP Users  
→ Go to page 18



## For Windows® 98/98SE/Me Users Only

Make sure that you followed the instructions in ① to ⑮ on pages 12 to 14.

- ⑮ When this screen appears, turn on the MFC by plugging in the power cord. Connect the USB interface cable to your PC, and then connect it to the MFC.

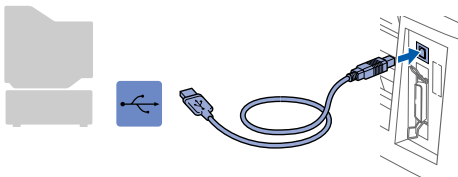
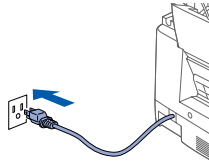
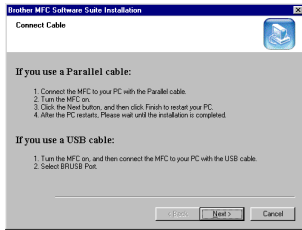

It will take a few seconds for the installation screen to appear.

The installation of the Brother driver will automatically start. Follow the instructions on the screen.

- ⑰ Select **BRUSB: USB Printer Port**, and then click **Next**.

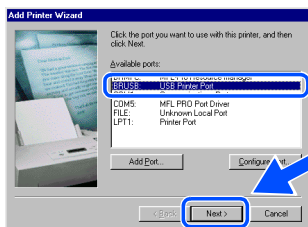

- ⑱ Accept the default Printer name by selecting **Yes**, and then click **Next**.

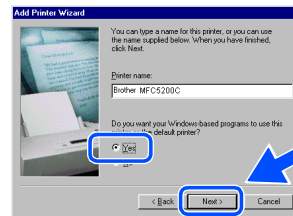

- ⑲ Select **Yes (recommended)**, and then click **Finish**. A test page will be printed so you can check the print quality.

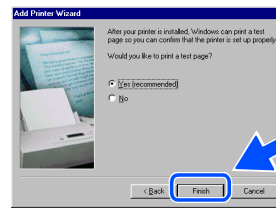

- ⑳ If the test page is printed correctly, click **Yes**. If you click **No**, follow the prompts on the screen to correct the problem.

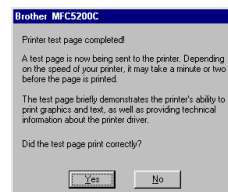

- ㉑ The README.WRI file will be displayed. Please read this file for troubleshooting information and then close the file to continue installation.

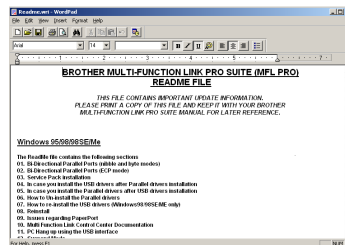

To be continued

# Step 2

# Installing the Driver & Software



For USB Interface Cable Users

(For Windows® 98/98SE/Me/2000 Professional/XP)

- 22 Click **Finish** to restart your computer.

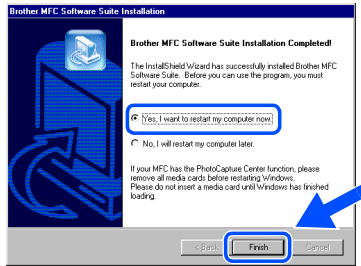

- 23 After the computer restarts, click **Yes** to have the Control Center loaded each time Windows is started. The Control Center will appear as an icon in the task tray. If you click **No** the Scan keys on the MFC will be disabled. \*3

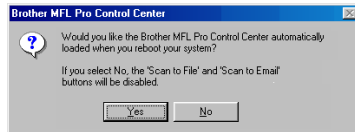

- \*3 *Even if you select **NO**, later you will be able to launch the Brother Control Center to use the **Scan to** key. See **AutoLoad the Brother Control Center, Chapter 14 in the On-Line Documentation (User's Guide) on the CD-ROM.***

- OK!** The Brother PC fax, Printer and Scanner drivers have been installed and the installation is now complete.

# For Windows® 2000 Professional Users Only

Make sure that you followed the instructions in ① to ⑮ on pages 12 to 14.

- ⑯ When this screen appears, turn on the MFC by plugging in the power cord. Connect the USB interface cable to your PC, and then connect it to the MFC.

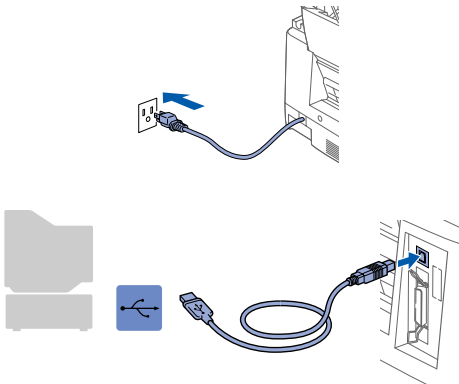
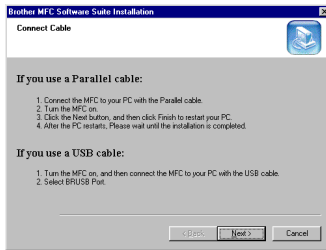

It will take a few seconds for the installation screen to appear.

The installation of the Brother driver will automatically start. Follow the instructions on the screen.

- ⑰ If the **Digital Signature Not Found** dialog boxes appear, click **Yes** to install the driver.

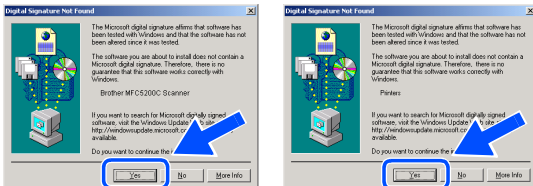

- ⑱ The README.WRI file will be displayed. Please read this file for troubleshooting information and then close the file to continue installation.

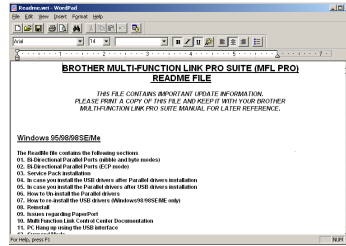

- ⑲ Click **Finish** to restart your computer.

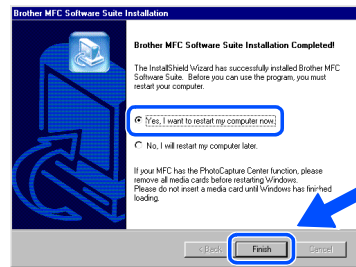

- ⑳ After the computer restarts, click **Yes** to have the Control Center loaded each time Windows is started. The Control Center will appear as an icon in the task tray. If you click **No** the Scan keys on the MFC will be disabled. \*3

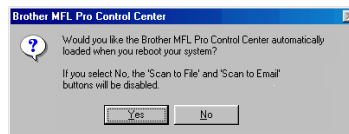

- \*3 Even if you select **NO**, later you will be able to launch the Brother Control Center to use the **Scan to** key. See *AutoLoad the Brother Control Center, Chapter 14 in the On-Line Documentation (User's Guide) on the CD-ROM.*

- OK!** The Brother PC fax, Printer and Scanner drivers have been installed and the installation is now complete.



For USB Interface Cable Users  
(For Windows® 98/98SE/Me/2000 Professional/XP)

## For Windows® XP Users Only

Make sure that you followed the instructions in 1 to 15 on pages 12 to 14.

- 16 When this screen appears, turn on the MFC by plugging in the power cord. Connect the USB interface cable to your PC, and then connect it to the MFC.

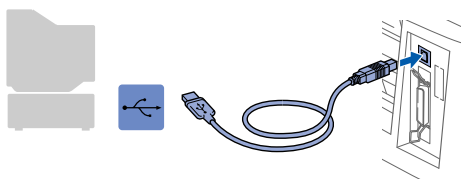
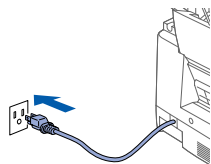
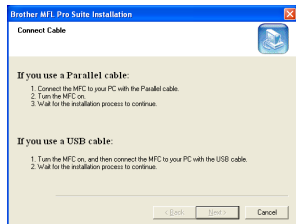

It will take a few seconds for the installation screen to appear.

The installation of the Brother driver will automatically start. Follow the instructions on the screen.

- 17 The README.WRI file will be displayed. Please read this file for troubleshooting information and then close the file to continue installation.

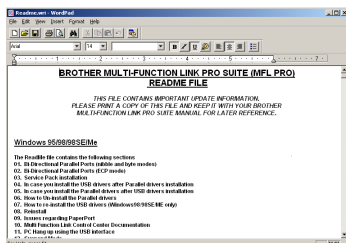

- 18 Click **Finish** to restart your computer.

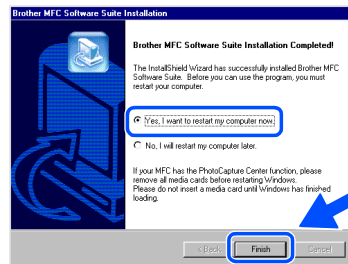

- OK! The Brother PC fax, Printer and Scanner drivers have been installed and the installation is now complete.

## For Parallel Interface Cable Users (For Windows® 95/98/98SE/Me/2000 Professional/XP)

Make sure that you have completed the instructions from Step 1 "Setting Up the MFC" on pages 2 to 9.

- 1 Unplug the MFC from the AC outlet and disconnect it from your computer, if you already connected an interface cable.

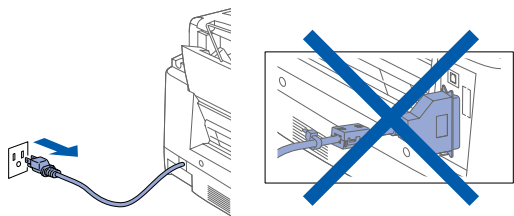

- 2 Turn on your computer.  
(For Windows® 2000 Professional/XP, you must be logged on as the administrator.)
- 3 Insert the supplied CD-ROM into your CD-ROM drive.



- 4 The CD-ROM main menu will appear.  
Click **Install Software**.



-  If this window does not appear, use Windows® Explorer to run the **setup.exe** program from the root directory of the Brother CD-ROM.

- 5 Click **Multi-Function Link® Pro Suite** in Main Application. \*1

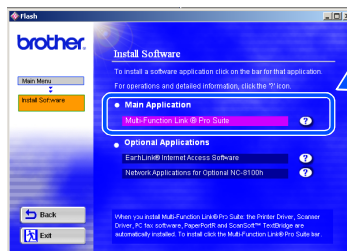

- \*1 *Multi-Function Link® Pro Suite includes Printer Driver, Scanner Driver, ScanSoft™ PaperPort®, ScanSoft™ Text Bridge®, PC-FAX software, Remote Setup and True Type fonts. PaperPort® is a document management application for viewing scanned documents. ScanSoft™ TextBridge®, which is integrated into PaperPort®, is an OCR application that converts an image into text and inserts it into your default word processor.*

- 6 Click **Install**.



If you see the following screen, click **OK** to install the Windows® updates. After the updates are installed your PC will restart and automatically continue the installation.

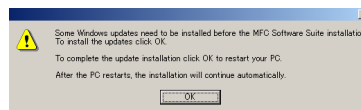

If the installation does not continue automatically, please open the installer menu again by double-clicking the **setup.exe** program on the Brother CD-ROM, and continue from Step 4.

To be continued

# Step 2

# Installing the Driver & Software

## For Parallel Interface Cable Users (For Windows® 95/98/98SE/Me/2000 Professional/XP)

- 7 When the PaperPort® 8.0 SE Setup window is displayed, click **Next**.

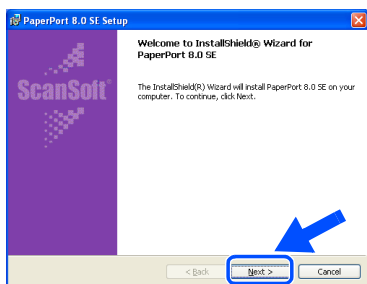

- 8 After reading and accepting the License Agreement, enter your user information and click **Next**.

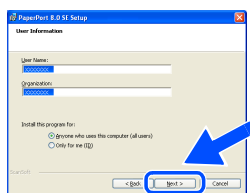
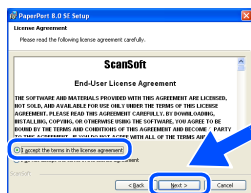

- 9 Select **Typical** and click **Next**.

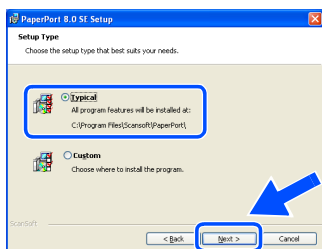

- 10 Click **Install** and PaperPort® will start installing on your computer.

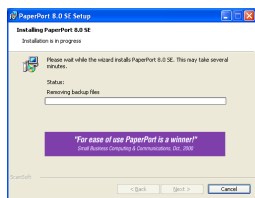
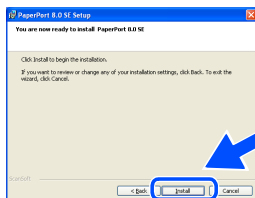

- 11 When the Registration screen is displayed, make your selection and follow the on screen instructions.

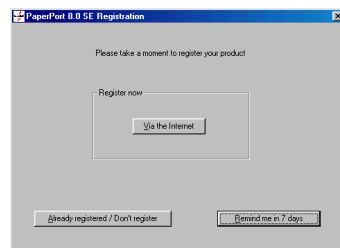

- 12 Click **Finish** to complete installation.

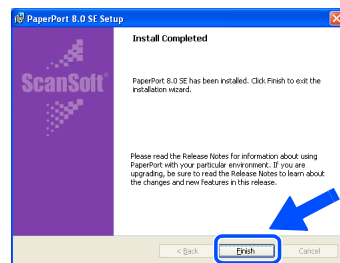

- 13 When the Brother MFL Pro Suite Installation window appears, click **Next**. \*2

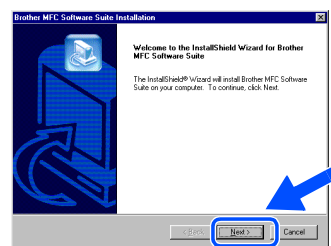

\*2 If an error message appears during the installation process, or if you have previously installed the MFL Pro Suite, you will first have to uninstall it. From the **Start** menu, select **Programs, Brother, Brother MFL Pro Suite, Uninstall**, and then follow the instructions on the screen.

- 14 When Software License Agreement window appears, click **Yes**.



- 15 Select **Standard**, and then click **Next**.  
The application files will be copied to your computer.

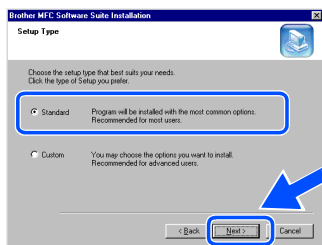

*You must attach the bundled filter core and cable tie to the parallel interface cable before you connect it to your PC and the MFC.*

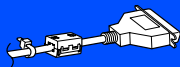

Windows® 95/98/98SE/Me Users  
→ Go to page 22  
Windows® 2000 Professional Users  
→ Go to page 23  
Windows® XP Users  
→ Go to page 24

## For Parallel Interface Cable Users (For Windows® 95/98/98SE/Me/2000 Professional/XP)

### For Windows® 95/98/98SE/Me Users Only

Make sure that you followed the instructions in 1 to 15 on pages 19 to 21.

- 16 When this screen appears, connect the parallel interface cable to your PC, and then connect it to the MFC. Turn on the MFC by plugging in the power cord.

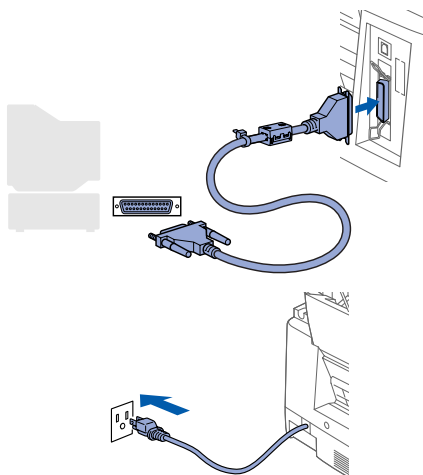
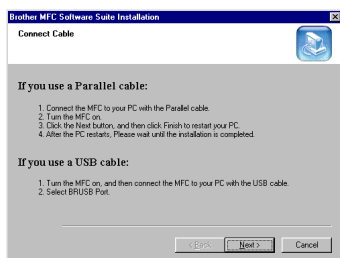

- 17 Click **Next**.

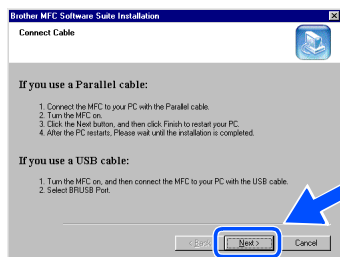

- 18 The README.WRI file will be displayed. Please read this file for troubleshooting information and then close the file to continue installation.

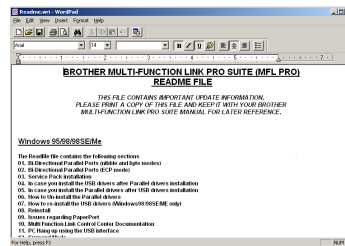

- 19 Click **Finish** to restart your computer.

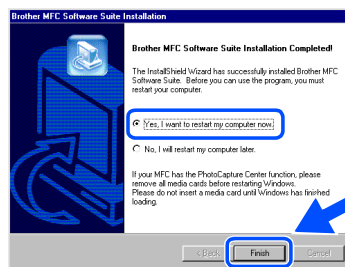

- 20 After the computer restarts, the installation of the Brother driver will automatically start. Follow the instructions on the screen.

- 21 Click **Yes** to have the Brother MFL-Pro Control Center loaded each time Windows is started. The Control Center will appear as an icon in the task tray. If you click **No** the Scan keys on the MFC will be disabled. \*3

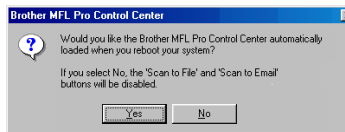

\*3 Even if you select **NO**, later you will be able to launch the Brother Control Center to use the **Scan to** key. See *AutoLoad the Brother Control Center, Chapter 14 in the On-Line Documentation (User's Guide) on the CD-ROM.*

- OK!** The Brother PC fax, Printer and Scanner drivers have been installed and the installation is now complete.



# For Windows® 2000 Professional Users Only

Make sure that you followed the instructions in ① to ⑮ on pages 19 to 21.

- ⑯ When this screen appears, connect the parallel interface cable to your PC, and then connect it to the MFC. Turn on the MFC by plugging in the power cord.

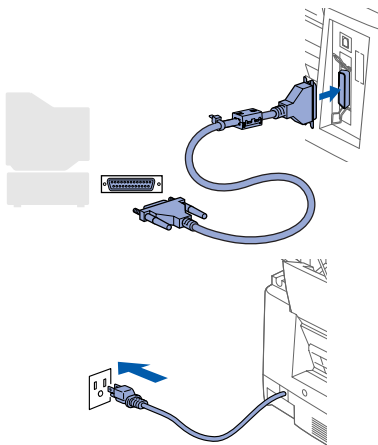
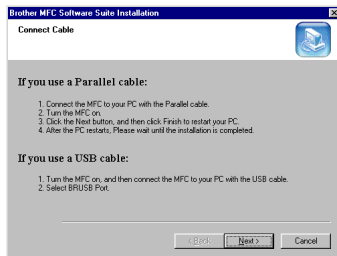

- ⑰ Click the **Next**.

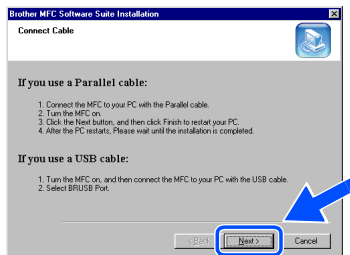

- ⑱ The README.WRI file will be displayed. Please read this file for troubleshooting information and then close the file to continue installation.

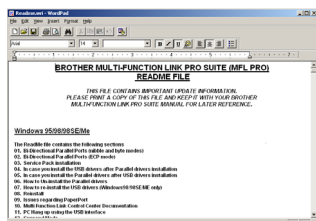

- ⑲ Click **Finish** to restart your computer.

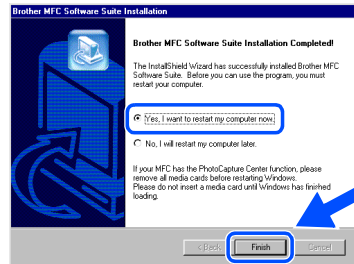

- ⑳ After the computer restarts, the installation of the Brother driver will automatically start. Follow the instructions on the screen.

- ㉑ If the **Digital Signature Not Found** dialog boxes appear, click **Yes** to install the driver.

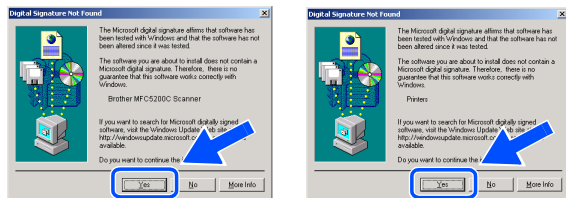

- ㉒ Click **Yes** to have the Control Center loaded each time Windows is started. The Control Center will appear as an icon in the task tray. If you click **No** the Scan keys on the MFC will be disabled. \*3



- \*3 Even if you select **NO**, later you will be able to launch the Brother Control Center to use the **Scan to** key. See *AutoLoad the Brother Control Center, Chapter 14 in the On-Line Documentation (User's Guide) on the CD-ROM.*

- OK! The Brother PC fax, Printer and Scanner drivers have been installed and the installation is now complete.

## For Parallel Interface Cable Users (For Windows® 95/98/98SE/Me/2000 Professional/XP)

### For Windows® XP Users Only

Make sure that you followed the instructions in ① to ⑮ on pages 19 to 21.

- ⑯ When this screen appears, connect the parallel interface cable to your PC, and then connect it to the MFC. Turn on the MFC by plugging in the power cord.

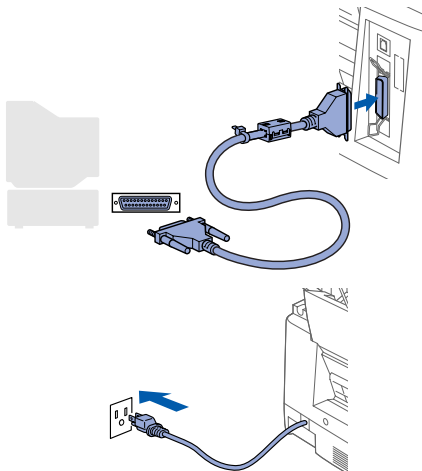
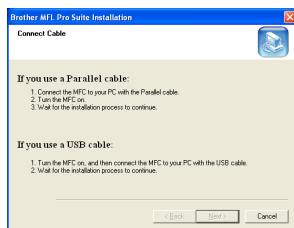

- ⑰ When the following screen appears, click **Finish** and wait as the PC restarts Windows and continues the installation.

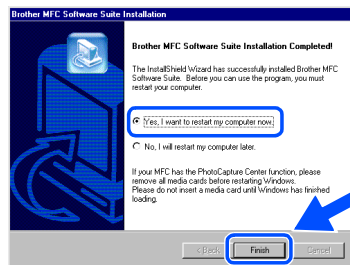

- OK! The Brother PC fax, Printer and Scanner drivers have been installed and the installation is now complete.

The installation of the Brother driver will automatically start. Follow the instructions on the screen.

- ⑱ The README.WRI file will be displayed. Please read this file for troubleshooting information and then close the file to continue installation.

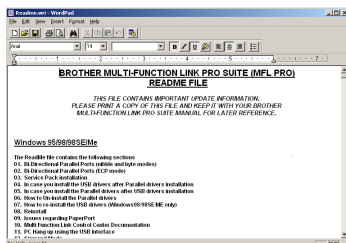



## For Windows NT® Workstation Version 4.0 Users

Make sure that you followed the instructions from Step 1 “Setting Up the MFC” on pages 2 to 9.

- 1 Turn on your computer. You must be logged on as the Administrator.
- 2 Connect the parallel interface cable to your computer, and then connect it to the MFC.

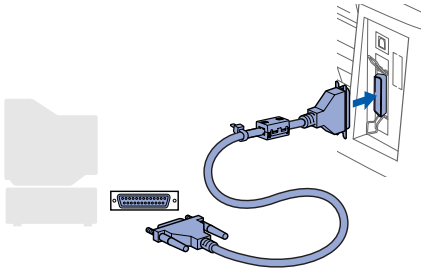

- 3 Make sure you turned on the MFC by plugging in the power cord.

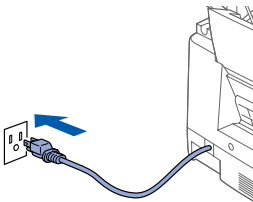

- 4 Insert the Supplied CD-ROM into your CD-ROM drive.



- 5 The CD-ROM main menu will appear. Click **Install Software**.

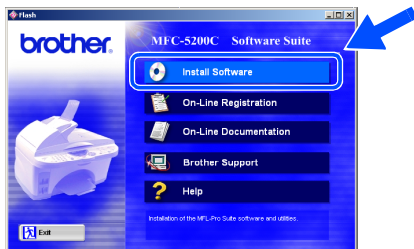

-  If this window does not appear, use Windows® Explorer to run the **setup.exe** program from the root directory of the Brother CD-ROM.

- 6 Click **Multi-Function Link® Pro Suite** in Main Application. \*1

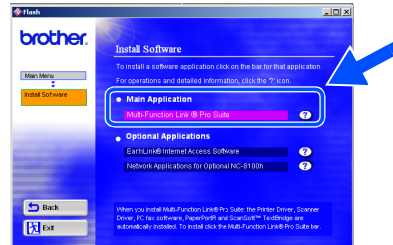

- \*1 Multi-Function Link® Pro Suite includes Printer Driver, Scanner Driver, ScanSoft™ PaperPort®, ScanSoft™ TextBridge®, PC-FAX software, Remote Setup and True Type fonts. PaperPort® is a document management application for viewing scanned documents. ScanSoft™ TextBridge®, which is integrated into PaperPort®, is an OCR application that converts an image into text and inserts it into your default word processor.

- 7 Click **Install**.

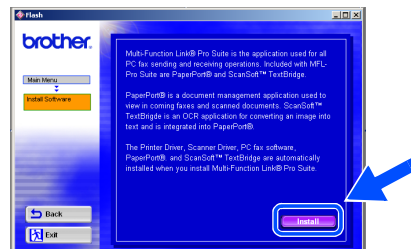

If you see the following screen, click **OK** to install the Windows® updates. After the updates are installed your PC will restart and automatically continue the installation.

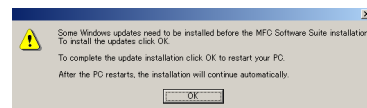

If the installation does not continue automatically, please open the installer menu again by double-clicking the **setup.exe** program on the Brother CD-ROM, and continue from Step 5.

To be continued

# Step 2

# Installing the Driver & Software



## For Windows NT<sup>®</sup> Workstation Version 4.0 Users

- 8 When the PaperPort<sup>®</sup> 8.0 SE Setup window is displayed, click **Next**.

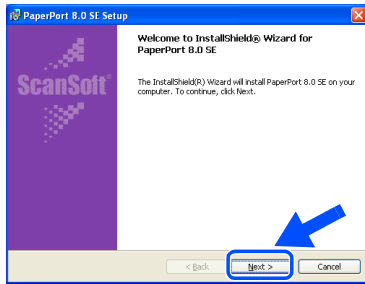

- 12 When the Registration screen is displayed, make your selection and follow the on screen instructions.

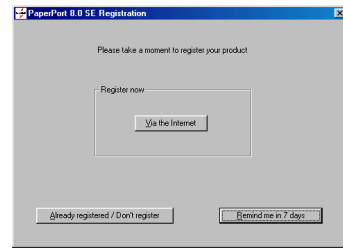

- 9 After reading and accepting the License Agreement, enter your user information and click **Next**.

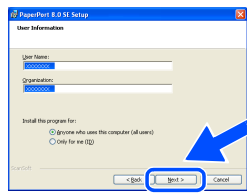
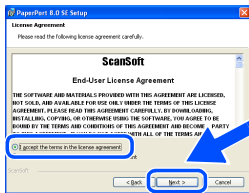

- 13 Click **Finish** to complete installation.

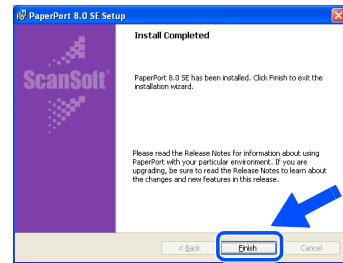

- 10 Select **Typical** and click **Next**.

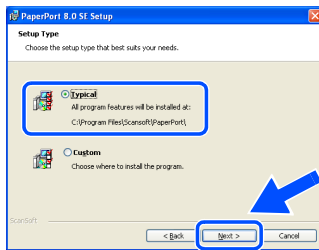

- 14 When the Brother MFL Pro Suite Installation window appears, click **Next**. \*2

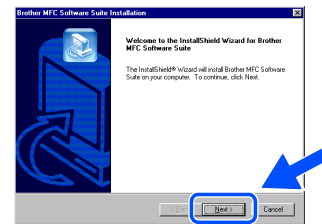

- 11 Click **Install** and PaperPort<sup>®</sup> will start installing on your computer.

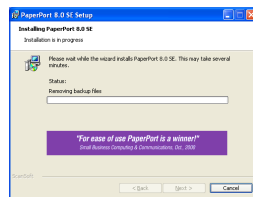
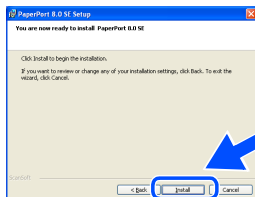

- \*2 If an error message appears during the installation process, or you have previously installed MFL Pro Suite, you will first have to uninstall it. From the **Start** menu, select **Programs, Brother, Brother MFL Pro Suite, Uninstall**, and then follow the instructions on the screen.

- 15 When Software License Agreement window appears, click **Yes** if you agree to it and go to next screen.



- 16 When the Setup Type window appears, select **Standard**, and then click **Next**.

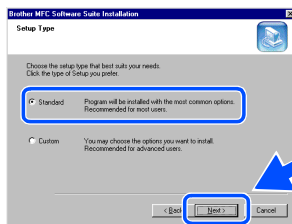

- 17 The README.WRI file will be displayed. Please read this file for troubleshooting information and then close the file to continue installation.

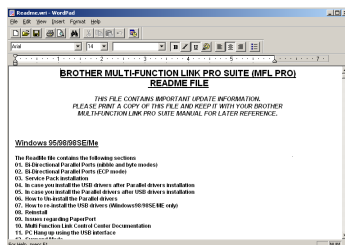

- 18 Click **Finish** restart your computer.

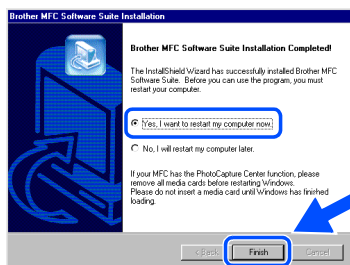

- 19 After the computer restarts, click **Yes** to have the Control Center loaded each time Windows is started. The Control Center will appear as an icon in the task tray. If you click **No** the Scan keys on the MFC will be disabled. \*3

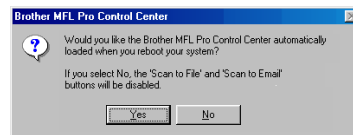

- \*3 Even if you select **NO**, later you will be able to launch the Brother Control Center to use the **Scan to** key. See *AutoLoad the Brother Control Center, Chapter 14 in the On-Line Documentation (User's Guide) on the CD-ROM.*

- OK! The Brother PC fax, Printer and Scanner drivers have been installed and the installation is now complete.

# Step 2

# Installing the Driver & Software

 For Mac® OS 8.5 - 9.2 Users

**Make sure that you have completed the instructions from Step 1 “Setting Up the MFC” on pages 2 to 9.**

- 1 Unplug the MFC from the AC outlet and disconnect it from your Macintosh if you already connected an interface cable.

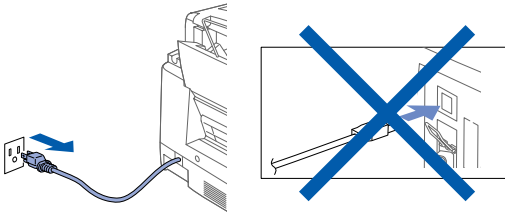

- 2 Turn on your Macintosh®.
- 3 Insert the supplied CD-ROM into your CD-ROM drive.



- 4 Double-click the **MFL Pro Suite Driver Installer** icon to install the printer and scanner drivers.

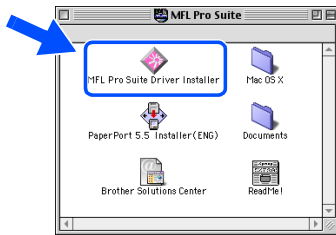

- 5 After the installation is completed, restart your Macintosh®.

- 6 Connect the USB interface cable to your Macintosh®, and then connect it to the MFC.

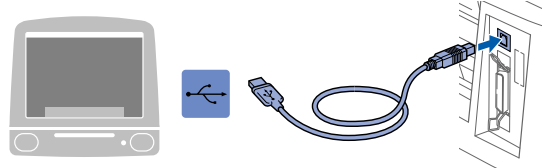

**Do not connect the MFC to a USB port on a keyboard or a non powered USB hub.**

- 7 Turn on the MFC by plugging in the power cord.

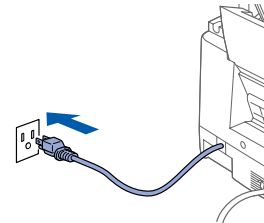

- 8 From the Apple® menu, open the **Chooser**.

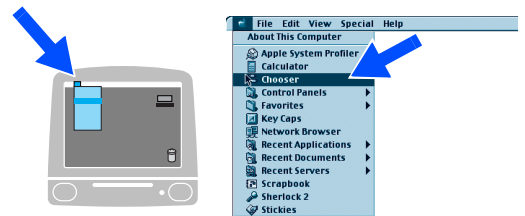

- 9 Click the **MFL Pro Color** icon you installed. On the right side of the **Chooser**, select the printer to which you want to print. Close the **Chooser**.

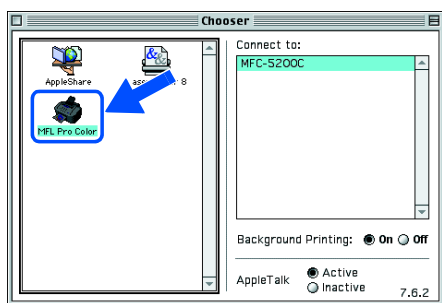

- OK! **The Brother PC fax, Printer and Scanner drivers have been installed and the installation is now complete.**

- 10 To install PaperPort®, double-click the **PaperPort® 5.5 Installer** icon.\*1 Follow the instructions on the screen.

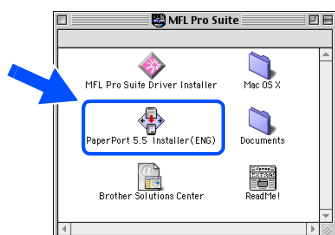

\*1 PaperPort® is a document management application for viewing scanned documents. ScanSoft™ TextBridge®, which is integrated into PaperPort®, is an OCR application that converts an image into text and inserts it into your default word processor.

# Step 2

# Installing the Driver & Software

 For Mac® OS X 10.1, 10.2.1 or greater Users

**Make sure that you have completed the instructions from Step 1 “Setting Up the MFC” on pages 2 to 9.**

- 1 Unplug the MFC from the AC outlet and disconnect it from your Macintosh if you already connected an interface cable.

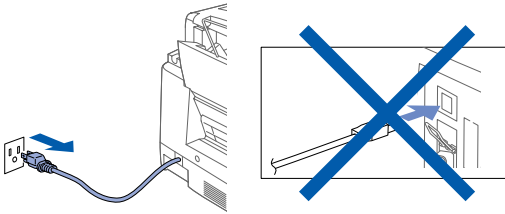

- 6 Connect the USB interface cable to your Macintosh®, and then connect it to the MFC.

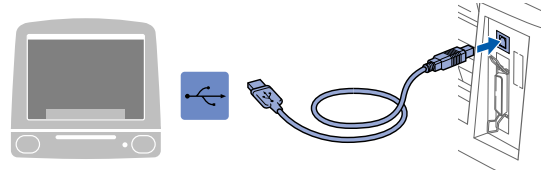

 **Do not connect the MFC to a USB port on a keyboard or a non powered USB hub.**

- 2 Turn on your Macintosh®.
- 3 Insert the supplied CD-ROM into your CD-ROM drive.



- 4 Double-click the **Mac OS X** folder to install the printer driver and Remote Setup program.



- 5 Double-click the **MFL Pro\_Color.pkg** icon. Follow the instructions on the screen.

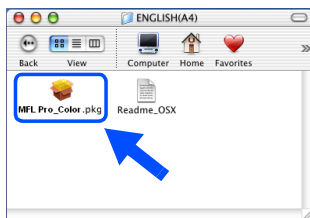

- 7 Turn on the MFC by plugging in the power cord.

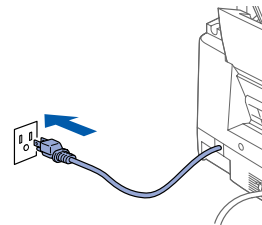

- 8 Open the **Macintosh HD** icon.

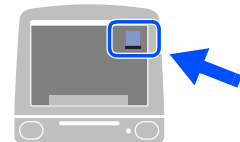

- 9 Open the **Applications** folder. Open the **Utilities** folder.

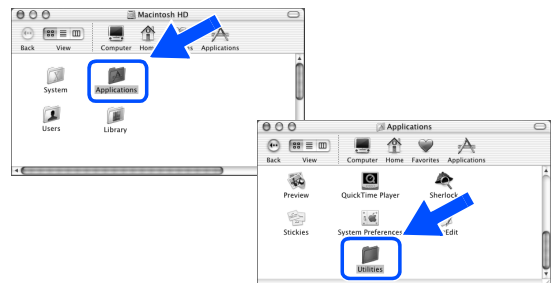



- 10 Open the **Printer Center** icon.

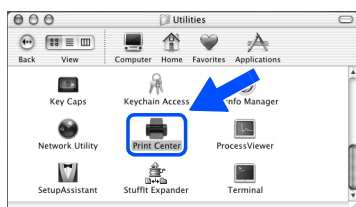

- 11 Click **Add Printer...**

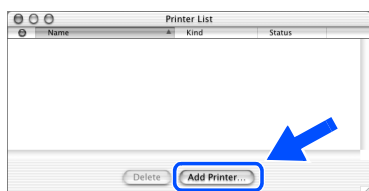

- 12 Select **USB**.

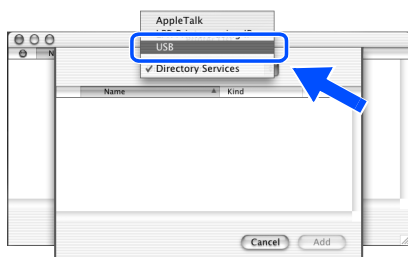

- 13 Select **MFC-5200C**, and then click **Add**.

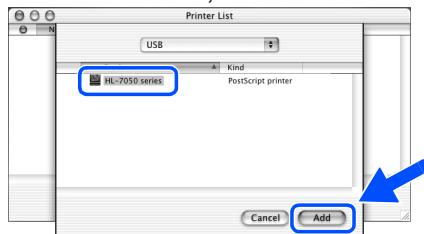

- 14 Select **Quit Printer Center** from the **Printer Center** menu.

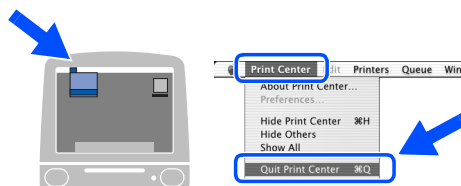

- OK!** The **Brother Printer, Scanner drivers** and **Remote Setup Program** have been installed and the installation is now complete.  
(Scanner driver is only available for OS X 10.2.1 or greater.)

## Trademarks

The Brother logo is a registered trademark of Brother Industries, Ltd.

Brother is a registered trademark of Brother Industries, Ltd.

PhotoCapture Center is a trademark of Brother International Corporation.

Multi-Function Link and True2Life are registered trademarks of Brother International Corporation.

© Copyright 2002 Brother Industries, Ltd. All rights reserved.

Windows and Windows NT, Microsoft and MS-DOS are registered trademarks of Microsoft in the U.S. and other countries.

Macintosh and QuickDraw, iMac and iBook are registered trademarks of Apple Computer, Inc.

PaperPort and TextBridge are registered trademarks of ScanSoft, Inc.

Hammermill and JetPrint PHOTO are a registered trademark of International Paper.

Smart Media is a trademark of Toshiba Corporation.

Compact Flash is a trademark of SanDisk Corporation.

Memory Stick is a trademark of Sony Corporation.

Each company whose software title is mentioned in this manual has a Software License Agreement specific to its proprietary programs.

**All other brand and product names mentioned in this manual are registered trademarks of their respective companies.**

## Compilation and Publication

Under the supervision of Brother Industries Ltd., this manual has been compiled and published, covering the latest product descriptions and specifications.

The contents of this manual and the specifications of this product are subject to change without notice.

Brother reserves the right to make changes without notice in the specifications and materials contained herein and shall not be responsible for any damages (including consequential) caused by reliance on the materials presented, including but not limited to typographical and other errors relating to the publication.

This product is designed for use in a Professional Environment.

**brother**®